

Electronic Dual Acting Foot Pedal 964 000 series



1. Mechanical Specifications:

- Two “built-in” return springs
- Die cast aluminium treadle support and mounting plate
- Zinc plated treadle with 500 hours salt spray protection
- C € certified

Travel angle	+/- 15°
Protection classification	IP66
Storage temperature	-40°C to +95°C
Operating temperature	-40°C to +85°C
Connector	AMP - 6 pins - waterproof (IP69)

- Options:
 - Wide treadle plate
 - Adjustable plate (15°, 25° or 35°)
 - Hand lever
 - Rubber cover
 - Twin sensors
 - Connector kit or customized wire harness
- Technical specification sheet and part numbers are available upon request

2. Electrical Specifications:

- Complies with 72/245/EEC
- E1 number 03 5754

All Electronic Controls are fitted with programmable Hall Effect Sensors.

The signals generated by the Electronic Controls will allow a smooth and precise control of your throttle control, hydrostatic drive control or implement control application.

The output values are programmable and hence can be adapted to the customer’s specifications. Electronic Controls can be connected directly to the Electronic Control Module.

For Available programmable sensor models, please refer to pages 3 and 4.

A/ Programmable single analogue sensor with programmable electronic Idle Validation Switch (IVS)

Analogue channel :

Current consumption	< 7,5mA
Supply (Vs)	Between 5V and 28 V DC
Output signal value	Between 5% and 95% (+/- 1%) of 5V DC
Output current	Max 1mA

Switch channel option 1 :

Current consumption	< 10mA
Supply (Vs)	Between 8V and 36V DC
Idle Validation Switch	Configurable (Open collector, Pull-up or Pull-down)
Output current	Max 10mA

Switch channel option 2 :

Current consumption	< 10mA
Supply (Vs)	Between 8V and 36V DC
Redundant Idle Validation Switch (2 outputs)	Output 1 : High - Low (5 - 0V) Output 2 : Low - High (0 - 5V)
Output current	Max 1mA / output

Examples:

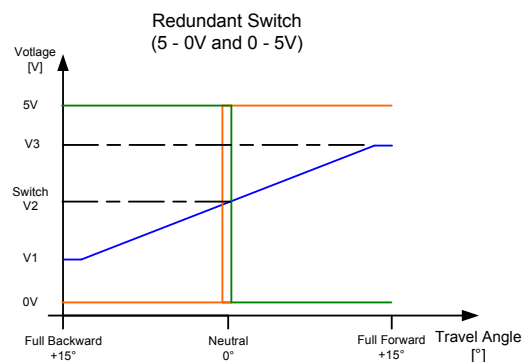
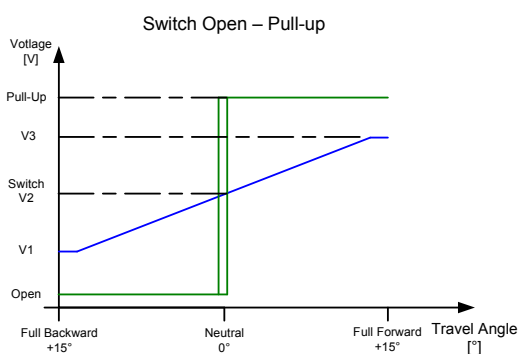

Example with twin sensors option:

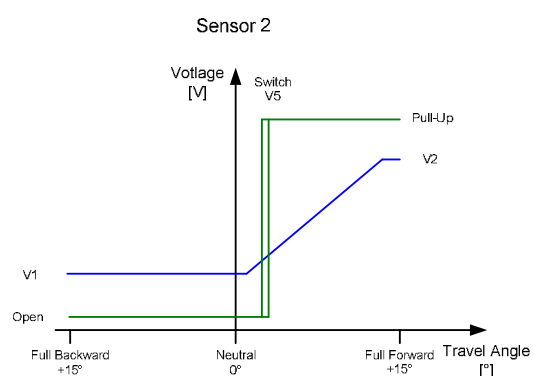
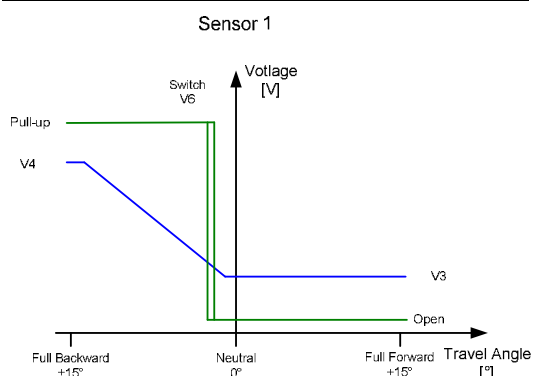

B/ Programmable dual output analogue sensor

Current consumption	< 8mA / channel
Supply (Vs)	5V DC / channel
Output channel #1	Between 5% and 95% (+/- 1%) of Vs
Output channel #2	Between 5% and 95% (+/- 1%) of Vs
Output current	Max 1mA / channel

Examples:

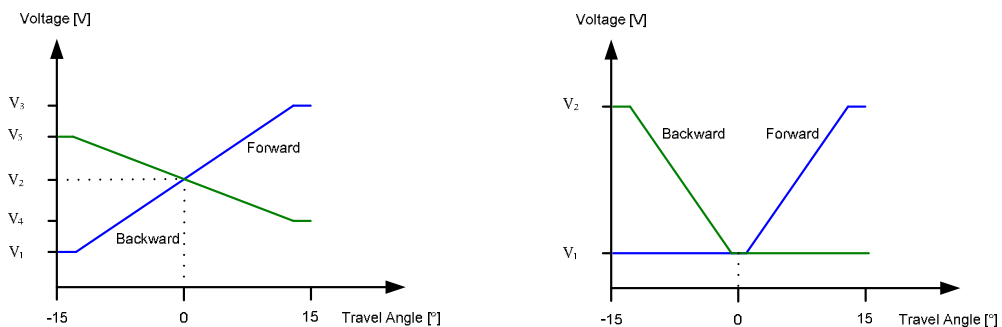

C/ Programmable single or dual output digital sensor (PWM)

Digital channel(s):

Current consumption	< 12mA / channel
Supply (Vs)	Between 8 and 36 V DC
Output channel #1	Duty cycle between 5% and 95% (+/- 1%)
Output channel #2	Duty cycle between 5% and 95% (+/- 1%)
Frequency	200Hz to 500Hz +/-15%
Output current	Max 10mA / channel

Optional switch channel with single digital output:

Current consumption	< 10mA
Supply (Vs)	Between 8V and 36V DC
Idle Validation Switch	Configurable (Open collector, Pull-up or Pull-down)
Output current	Max 10mA

Examples:

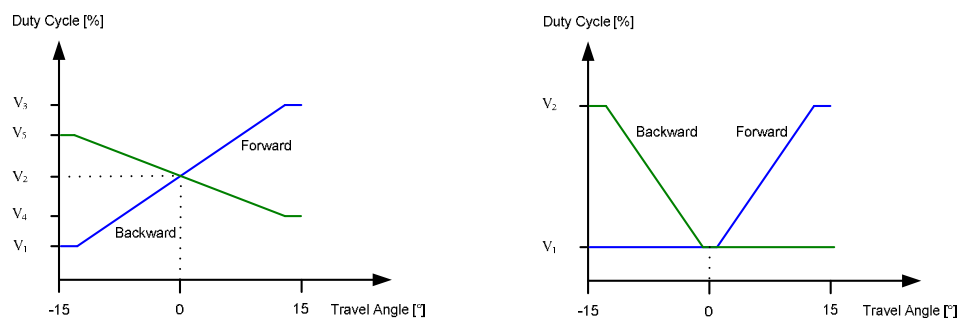

3. Options:

A/ CAN J1939

J1939 Parameters:

- J1939 Messages and signals can be activated according to MCS Throttle default values or customer specifications.
- J1939 Parameters like SA (Source Address) or NAME fields can be set according to MCS Throttle default values or customer specifications.
- Optional messages such as DTC (DMx, FMI, MIL, ...) can be activated upon customer request.

Electrical specifications:

Power Supply	+8 .. 32VDC
Current consumption	40mA max.
J1939 Connector	Deutsch #DT06-3S (J1939/11)



B/ 4-20mA current output signals

Power Supply	+8 .. 32VDC
Current output signal	4 - 20mA

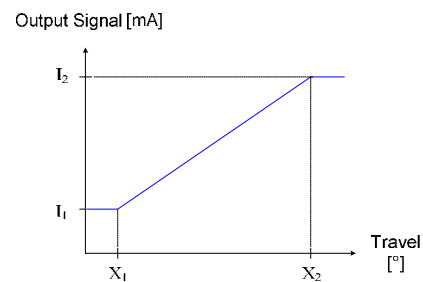

C/ Customized parts available



Narrow or wide treadle plate



With narrow or wide tilting plate

4. Drawings:

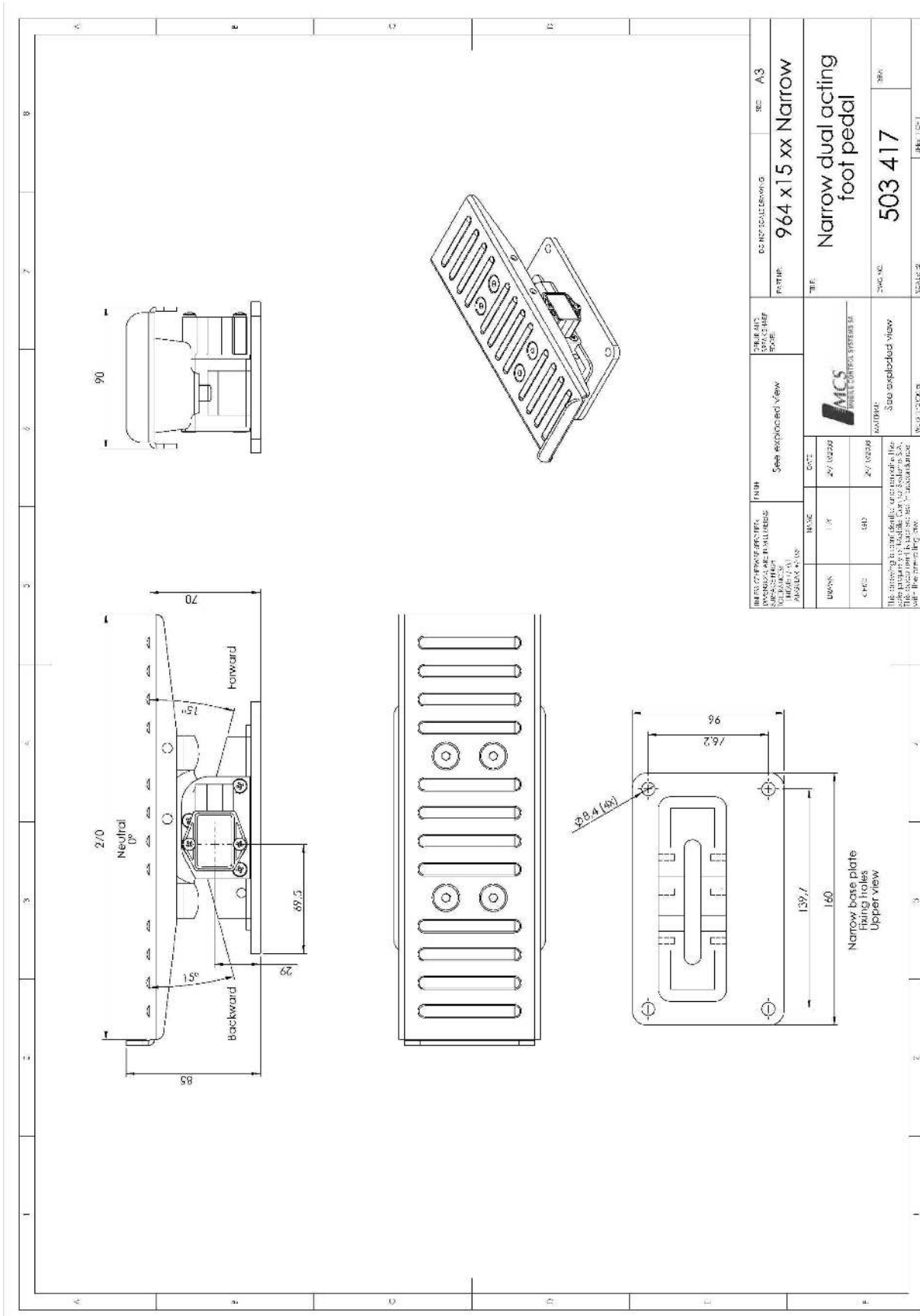

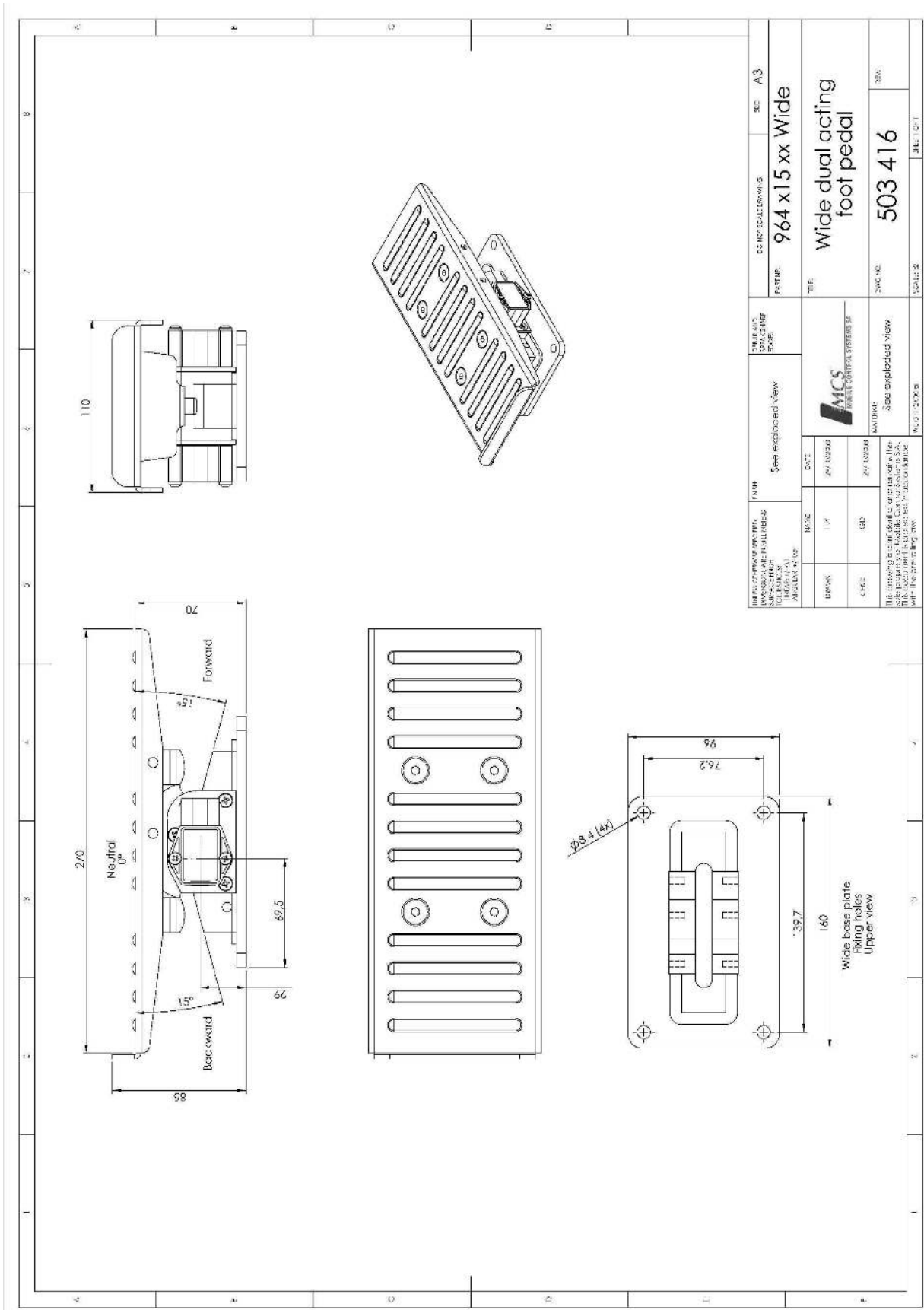

5. Typical Applications:

