

# **Electronic Side Mounted Direct Drive Hand Throttle 976 000 series**



## **1. Mechanical Specifications:**

- No return spring
- Allows engine constant RPM at selected rate through lever position
- Easy to use in combination with Throttle Pedal or Throttle Position Sensor
- Very convenient whenever engine is operated from a/several remote stations
- C € certified

Travel angle	45°
Protection classification	IP66
Storage temperature	-40°C to +95°C
Operating temperature	-40°C to +85°C
Connector	AMP - 6 pins - waterproof (IP69)

- Options:
  - Different coloured knobs available
  - Connector kit or customized wire harness
- Technical specification sheet and part numbers are available upon request

## **2. Electrical Specifications:**

- Complies with 72/245/EEC
- E1 number 03 5754

All Electronic Throttle Controls are fitted with programmable Hall Effect Sensors.

The signals generated by the Electronic Throttle Controls will allow a smooth and precise engine speed control.

The output values are programmable and hence can be adapted to the customer's specifications. Electronic Throttle Controls can be connected directly to the engine management system, or engine Electronic Control Module

For available programmable sensor models, please refer to pages 3 and 4.

## A/ Programmable single analogue sensor with programmable electronic Idle Validation Switch (IVS)

### Analogue channel :

<b>Current consumption</b>	< 7,5mA
<b>Supply (Vs)</b>	Between 5V and 28 V DC
<b>Output signal value</b>	Between 5% and 95% (+/- 1%) of 5V DC
<b>Output current</b>	Max 1mA

### Switch channel option 1 :

<b>Current consumption</b>	< 10mA
<b>Supply (Vs)</b>	Between 8V and 36V DC
<b>Idle Validation Switch</b>	Configurable (Open collector, Pull-up or Pull-down)
<b>Output current</b>	Max 10mA

### Switch channel option 2 :

<b>Current consumption</b>	< 10mA
<b>Supply (Vs)</b>	Between 8V and 36V DC
<b>Redundant Idle Validation Switch (2 outputs)</b>	Output 1 : High - Low (5 - 0V) Output 2 : Low - High (0 - 5V)
<b>Output current</b>	Max 1mA / output

### Examples:

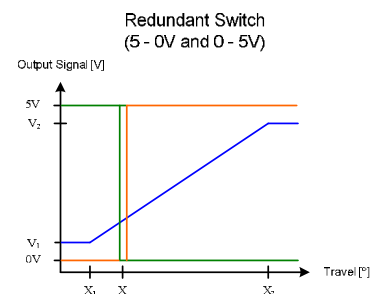
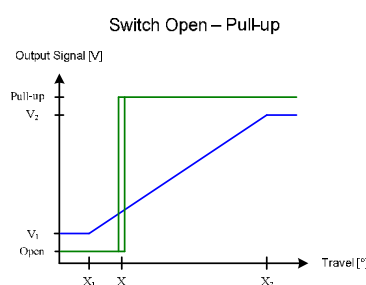
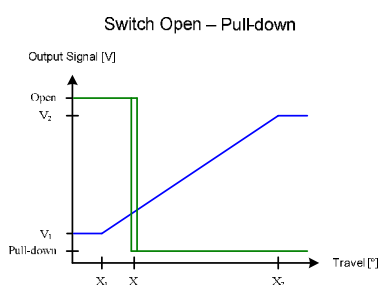

## B/ Programmable dual output analogue sensor

<b>Current consumption</b>	< 8mA / channel
<b>Supply (Vs)</b>	5V DC / channel
<b>Output channel #1</b>	Between 5% and 95% (+/- 1%) of Vs
<b>Output channel #2</b>	Between 5% and 95% (+/- 1%) of Vs
<b>Output current</b>	Max 1mA / channel

### Examples:

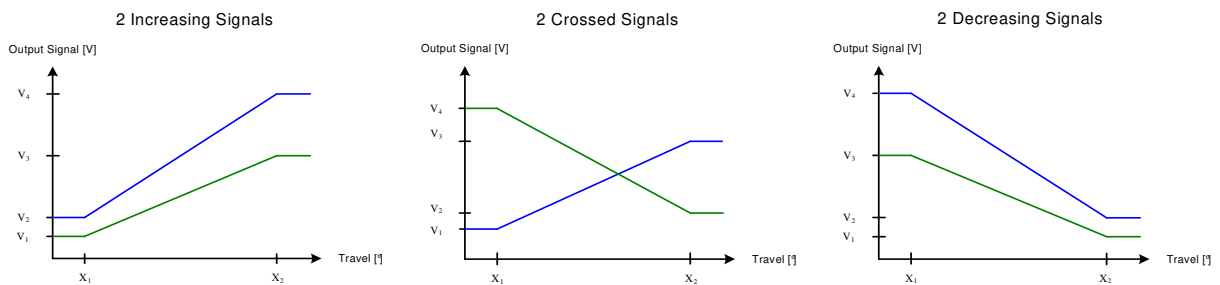

## C/ Programmable single or dual output digital sensor (PWM)

### Digital channel(s) :

<b>Current consumption</b>	< 12mA / channel
<b>Supply (Vs)</b>	Between 8 and 36 V DC
<b>Output channel #1</b>	Duty cycle between 5% and 95% (+/- 1%)
<b>Output channel #2</b>	Duty cycle between 5% and 95% (+/- 1%)
<b>Frequency</b>	200Hz to 500Hz +/-15%
<b>Output current</b>	Max 10mA / channel

### Optional Switch channel with single digital output :

<b>Current consumption</b>	< 12mA
<b>Supply (Vs)</b>	Between 8V and 36V DC
<b>Idle Validation Switch</b>	Configurable (Open collector, Pull-up or Pull-down)
<b>Output current</b>	Max 10mA

### Examples:

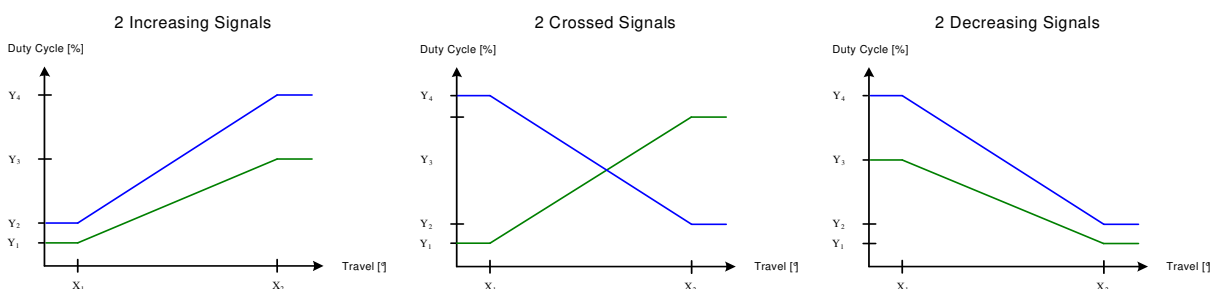

### 3. Options:

#### **A/ CAN J1939**

##### **J1939 Parameters:**

- J1939 Messages and signals can be activated according to MCS Throttle default values or customer specifications.
- J1939 Parameters like SA (Source Address) or NAME fields can be set according to MCS Throttle default values or customer specifications.
- Optional messages such as DTC (DMx, FMI, MIL, ...) can be activated upon customer request.

##### **Electrical specifications:**

Power Supply	+8 .. 32VDC
Current consumption	40mA max.
J1939 Connector	Deutsch #DT06-3S ( J1939/11 )

#### **B/ 4-20mA current output signals**

Power Supply	+8 .. 32VDC
Current output signal	4 - 20mA

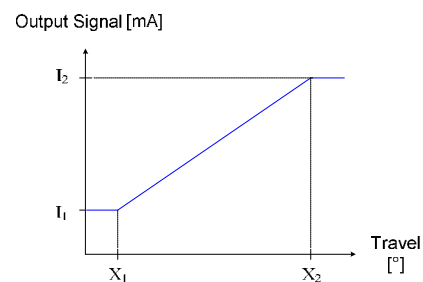

#### **C/ Customized parts available**



With horizontal lever



With bended lever



Different knobs available

## 4. Drawing:

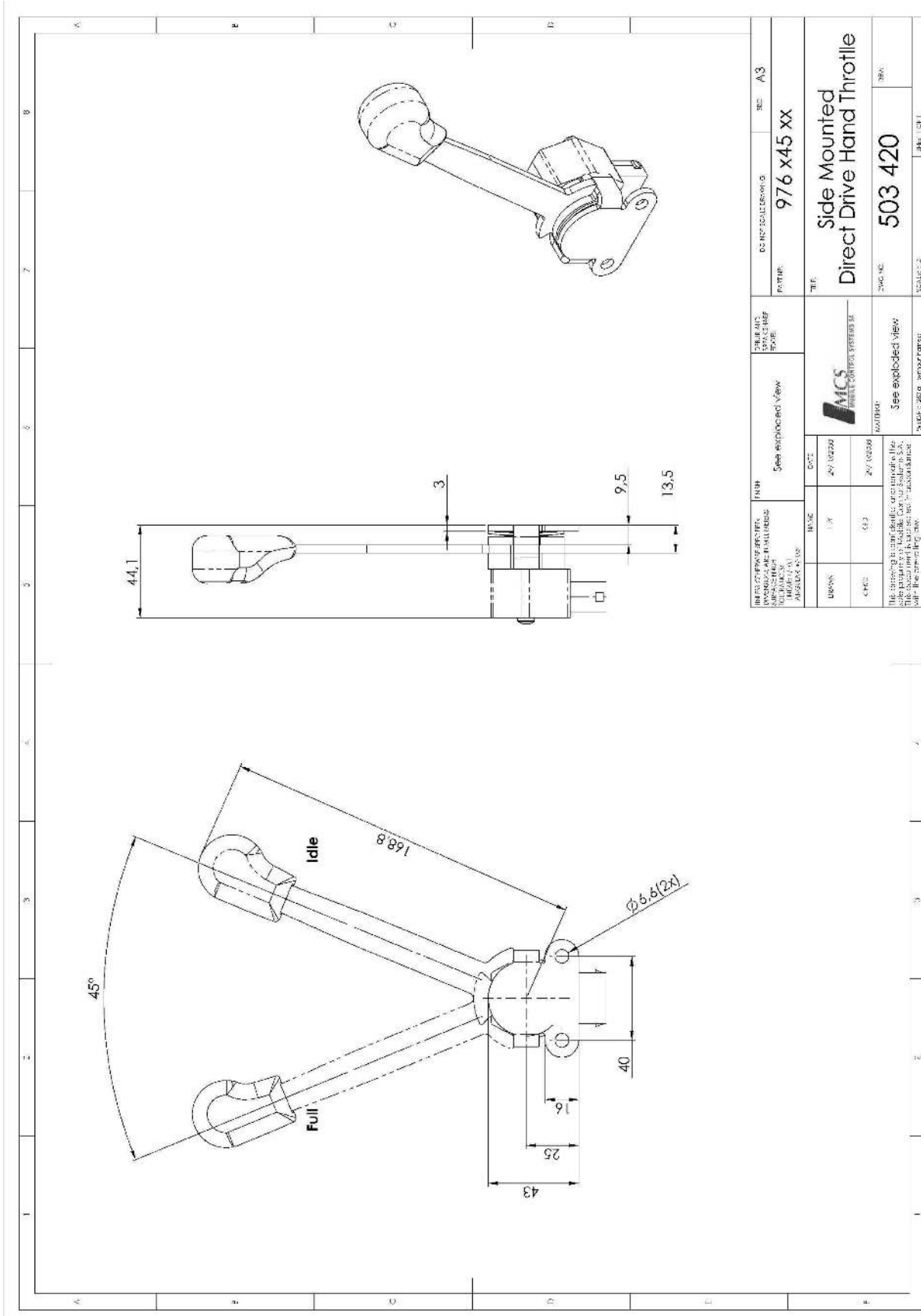

**5. Typical Applications:**



**6. Compatible with the following engines:**

- |                  |                 |                   |
|------------------|-----------------|-------------------|
| • CATERPILLAR    | • JCB           | • PERKINS         |
| • CUMMINS        | • JOHN DEERE    | • RENAULT         |
| • DACHAI         | • KUBOTA        | • SCANIA          |
| • DEAWOO         | • LIEBHERR      | • SHANGHAI DIESEL |
| • DAF            | • LOVOL         | • SISU DIESEL     |
| • DETROIT DIESEL | • MAN           | • VOLKSWAGEN      |
| • DEUTZ          | • MERCEDES-BENZ | • VOLVO           |
| • HINO           | • MTU           | • WEICHAI         |
| • ISUZU          | • NAVISTAR      | • YANMAR          |
| • IVECO          | • NISSAN        | • YUCHAI          |