

Elektrische Anzeigeräte für Druck, Temperatur, Volt oder Vorrat (Gehäuse Ø 52 mm)

Electric Indicating Instruments For Pressure, Temperature, Voltage Or Level (Housing Dia., 52 mm)

Auflichtausführung VDO cockpit international

Floodlight Type VDO cockpit international

Beschreibung:

Analoge Anzeige von entsprechenden Messwerten in Verbindung mit einem separaten Geber (Ausnahme Voltmeter).

Description:

Analog indication of corresponded measured values when connected to a separate sensor (exception voltmeter).

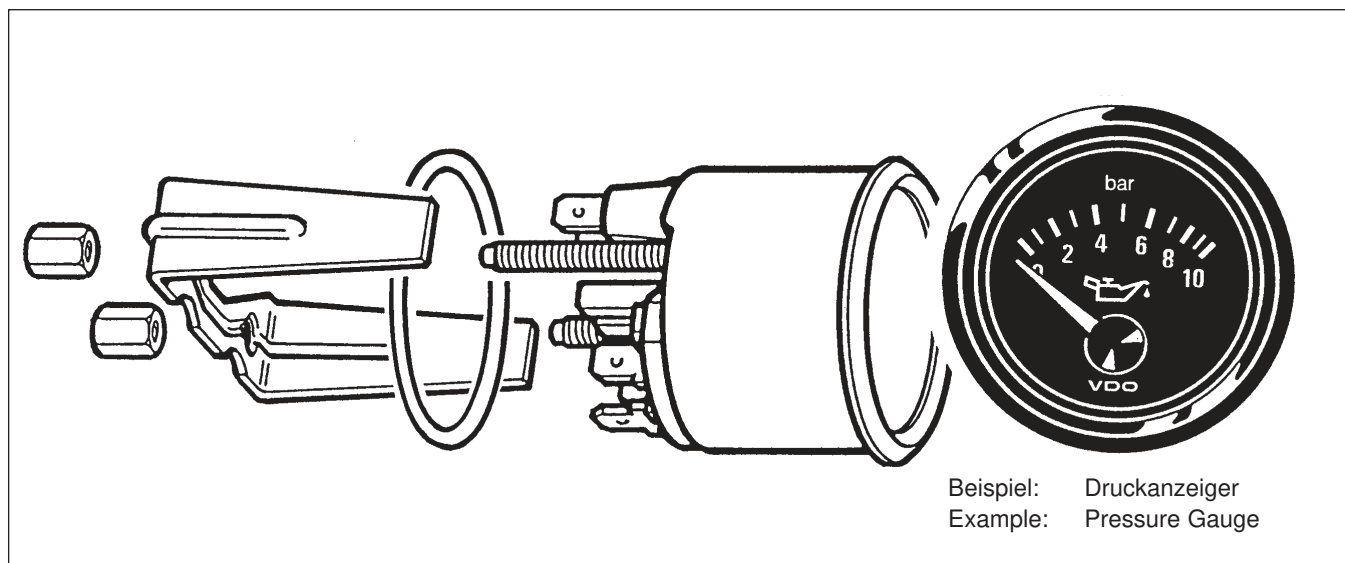

Ausführung:

Frontring:	schwarz, Dreikantausführung
Deckglas:	entspiegelt
Einlegering:	schwarz
Zifferblatt:	
Aufdruck:	Grund schwarz Skala, Ziffern und Symbol weiß
Zeiger:	Fahne rot, Nabe schwarz
Gehäuse:	St, verzinkt u. chromatiert
Befestigung:	Bügel, St, verzinkt und chromatiert
Anschlüsse:	Flachstecker 6,3 x 0,8mm

Design:

Bezel:	black, triangular version
Lens:	nonreflective
Deflector:	black
Dial:	
Dialgraphics:	black background with white characters
Pointer:	arm red; hub black
Housing:	steel, zinc-plated and chromated
Mounting:	bracket, steel, zinc-plated and chromated
Connections:	blade terminals 6.3 x 0.8mm

Elektrische Anzeigergeräte / Electric Indicating Instruments

Auflichtausführung / Floodlight Type VDO cockpit international

Technische Daten:

Betriebsspannung:	11V bis 16V oder 21,5V bis 30V
Stromaufnahme (ohne Beleuchtung):	
82mA	Druckanzeiger
131mA	Temperaturanzeiger
106mA	Temp.-Anz. 60 ... 200°C
67mA	Voltmeter 16V
63mA	Voltmeter 32V
86mA	Vorratsanzeiger (Hebelgeber)
96mA	Vorratsanzeiger (Tauchrohrg.)
Betriebstemperatur:	- 30°C bis + 85°C
Lagertemperatur:	- 40°C bis + 90°C
Schutzart:	IP64 DIN 40050 frontseitig verpolgeschützt
Nennlage:	NL 0 bis NL 90, DIN 16257
Schwingungsfestigkeit:	max. 1g eff., 25Hz bis 2000Hz Dauer 8 Std., f: 1 Oktave/Min.
Glühlampe:	14V 3,4W oder 24V 3W

Technical Data:

Operating voltage:	11V to 16V 21.5V to 30V
Current consumption (without illumination):	
82mA	pressure gauge
131mA	temperature gauge
106mA	temp. g. 60 ... 200°C
67mA	voltmeter 16V
63mA	voltmeter 32V
86mA	fuel level gauge (lever-type)
96mA	fuel level gauge (tubular type)
Operating temperature:	- 30°C to + 85°C
Storage temperature:	- 40°C to + 90°C
Protection:	IP64 DIN 40050 from the front reverse-polarity protection
Nominal position:	NL 0 to NL 90, DIN 16257
Vibration resistance:	1g eff. max., 25Hz to 2000Hz duration 8 h, f: 1 octave/min.
Light bulb:	14V 3.4W or 24V 3W

Abmaße (mm):

Dimensions (mm):

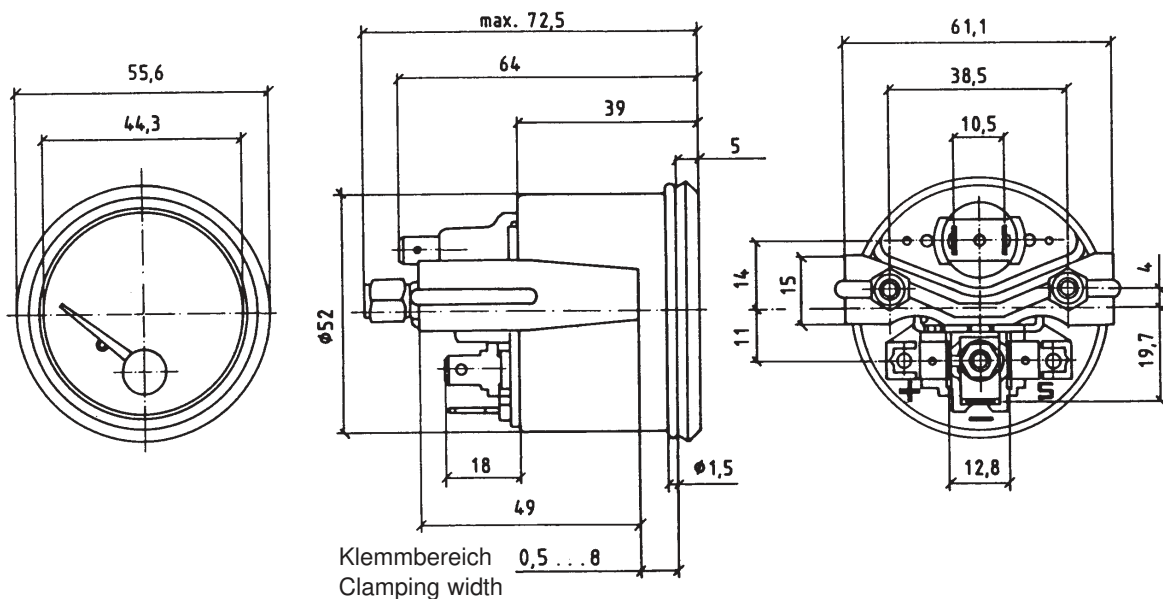

Anschlussbelegung / Pin assignment:















Pin+:	+ 12V oder / or + 24V Klemme / Terminal 15
Pin -:	Masse / Ground Klemme / Terminal 31
Pin S:	Geber / Sensor, nicht belegt bei Voltmeter / not assigned with voltmeter

Elektrische Anzeigergeräte / Electric Indicating Instruments

Auflichtausführung / Floodlight Type VDO cockpit international

Geräteübersicht

Instruments Survey

Messbereich Measuring Range	Zifferblattaufdruck Dialgraphics	Widerstandswerte Resistance Values Ω	Ausführung Version	Bestell-Nr. Order No.
Temperaturanzeiger		Temperature Gauges		
40 ... 120°C	 °C	287,4 ... 22,7	12V	310-030-002C 310-030-002G
100 ... 250°F 40 ... 120°C	 °C °F	287,4 ... 22,7	Doppelskala Dual scale	310-030-02C
40 ... 120°C	 °C	287,4 ... 22,7	12V	310-030-013C 310-030-013G
50 ... 150°C	 °C	322,8 ... 18,6	12V	310-030-003C 310-030-003G
50 ... 150°C	 °C	322,8 ... 18,6	12V	310-030-015C 310-030-015G
60 ... 200°C	°C	482,0 ... 14,3	12V	310-030-004C 310-030-004G
20 ... 100°C	 °C	700,0 ... 38,5	12V	310-030-022C
40 ... 120°C	 °C	287,4 ... 22,7	24V	310-040-002C 310-040-002G
100 ... 250°F 40 ... 120°C	 °C °F	287,4 ... 22,7	Doppelskala Dual scale	310-040-020C
40 ... 120°C	 °C	287,4 ... 22,7	24V	310-040-013C 310-040-013G
50 ... 150°C	 °C	322,8 ... 18,6	24V	310-040-003C 310-040-003G
50 ... 150°C	 °C	322,8 ... 18,6	24V	310-040-015C 310-040-015G
60 ... 200°C	°C	482,0 ... 14,3	24V	310-040-004C 310-040-004G
100 ... 300°F 50 ... 150°C	 °C °F	322,8 ... 18,6	Doppelskala Dual scale	310-040-021C
20 ... 100°C	 °C	700,0 ... 38,5	24V	310-040-022C
40 ... 120°C	 °C	287,4 ... 22,7	24V	310-040-025C