

FUSE BOXES

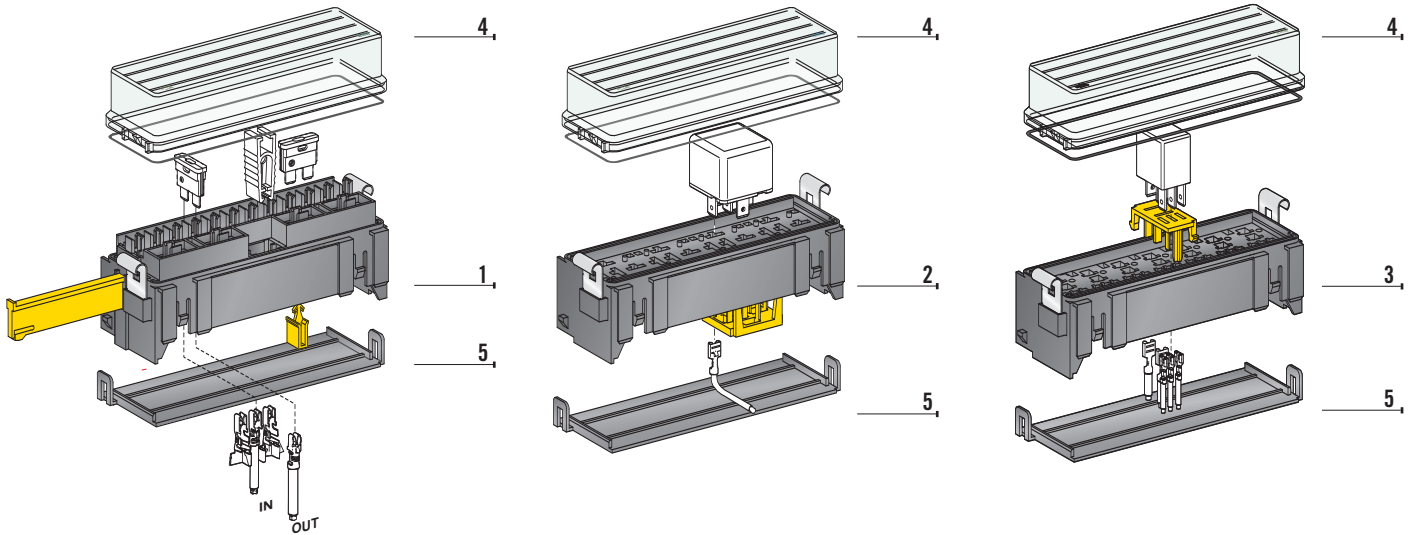

IMG	DESCRIPTION	WAY	MATERIAL	COLOUR	P/N KIT WITH COVER AND TERMINAL	M.O.Q.	P/N BULK	M.O.Q.
1	UNIVAL HOLDER	16	PA66 GF25	■Black	0100655	16	0300650	36
2	MINI RELAY HOLDER	4	PA66 GF25	■Black	0100665	16	0300660	72
3	MICRO RELAY HOLDER	7	PA66 GF25	■Black	0100705	16	0300700	100
4	COVER WITH GASKET		PC	□Natural			0300670	72
5	BOTTOM COVER		PA66	■Black			0300680	72

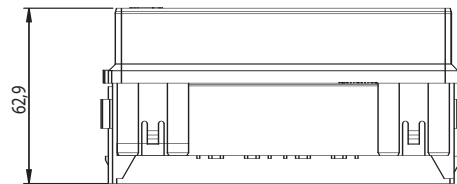
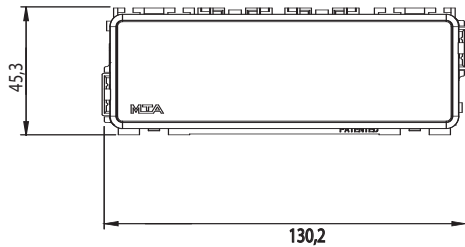

CONNECTIONS AND FIXINGS

0300690 0300691	UNI F630 BUS-BAR	UNI F630	FASTON F630 WITH LOCKING NOTCH	FASTON F480 PASSO 5	FASTON F630 THICKNESS 0,35	0300856	
IMG	1+2+3	1	1	2	3	3	1+2+3

CONNECTOR BOX

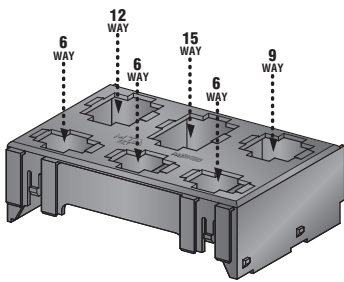

1

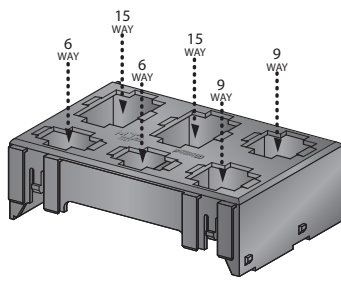

2

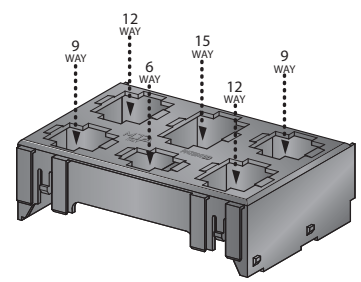

3

IMG	DESCRIPTION	WAY	MATERIAL	COLOUR		P/N BULK	M.O.Q.
1	CONNECTOR BOX	6	PA66 GF30	■ Black		0300681	125
2	CONNECTOR BOX	6	PA66 GF30	■ Black		0300683	125
3	CONNECTOR BOX	6	PA66 GF30	■ Black		0300684	125

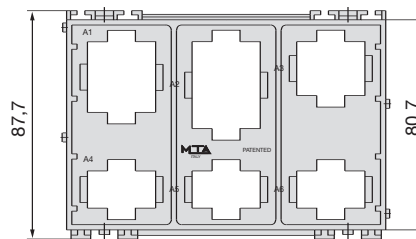
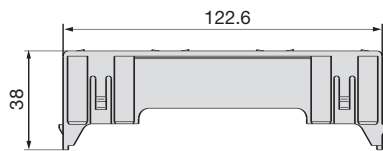

CONNECTIONS AND FIXINGS



4426120
6 VIE / WAY



4426140
9 VIE / WAY



4426160
12 VIE / WAY



4426180
15 VIE / WAY



0300690



0300691